

400T Thermal Curtainwall

Tubelite's thermally broken curtainwall product has been designed to meet or exceed today's stringent energy codes. The 400T Series has a 2-1/2" face, with system depths from 6-1/4" to 10-1/4" and optional polyamide pressure plates. The shear block system can be stick fabricated for field glazing.

Beauty and Performance

The expanded thermal break and thicker gasketing improves U-Factors and CRF over Tubelite's current 400CW thermal barrier system when using the same size and type of insulated glass. Glass is positioned to the system exterior for enhanced resistance to rainwater. Seven anodized finishes and 20 standard paint colors are available on this framing system to complement any project with warranted protection, as well as street appeal. The 400T also accepts Tubelite's Operable Windows, Therml=Block® Doors and Maxblock® Sunshades.

Therml=Block
Doors & Frames

ALSO
USED
WITH

14000 I/O Series
Multiplane
Storefront Framing

Vaisala US Headquarters, Louisville, CO
Photographer: Matt Puckett

TUBELITE[®]
DEPENDABLE

LEADERS IN ECO-EFFICIENT STOREFRONT,
CURTAINWALL AND ENTRANCE SYSTEMS

400T Thermal Curtainwall

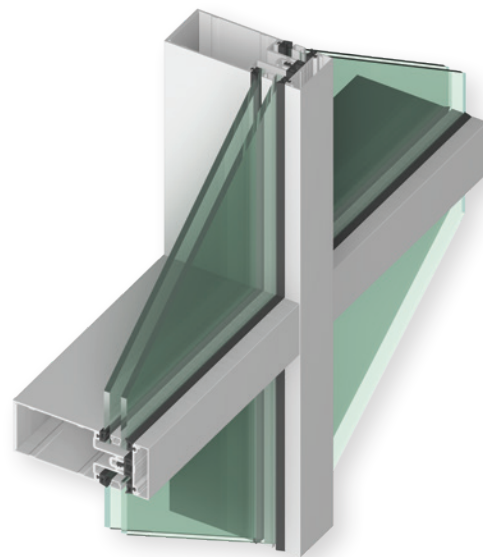
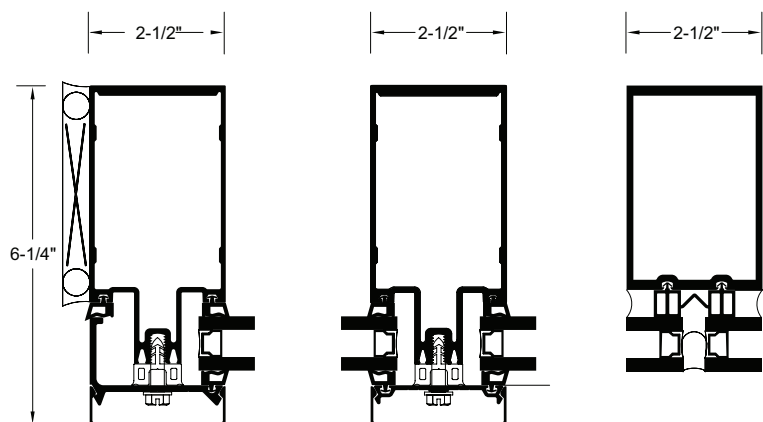

System Features

- Standard 6" (152.4mm) 7", 7-1/2", 8", 9" and 10" depth systems have a 2-1/2" (63.5mm) sight line
- Outside glazed pressure plate system available in captured and structural glazed configuration
- Standard infill option 1" (25.4mm), other infills available
- Thermally Broken using a continuous EPDM Isolator
- Concealed fastener joinery creates smooth, monolithic appearance
- Shear block fabrication method
- Open-back horizontals and perimeters are available for cost savings
- Silicone compatible glazing materials for long-lasting seals
- Captured & SSG inside and outside corners available

Optional Features

- Steel reinforcing available
- Optional deep profile and bull nose covers available
- Silicone glazed intermediate verticals & horizontals available
- Polyamide pressure plates available
- Easily integrates with Tubelite's Entrances, Operable Windows, and Maxblock sunshades.
- Deep and heavy-weight mullions available

400T Series Product Specifications

Application: Low and mid-rise commercial buildings including retail, office, healthcare, schools, etc.

Description: 2-1/2" x (6-1/4" to 10-1/4") field glazed, shear block construction curtainwall.

Face Width:	Overall Depths:	Glass Thickness:	Air Infiltration:	Water Infiltration:	Structural:	U-Factor**	CRF:	Acoustic:
2-1/2"	6-1/4" to 10-1/4"	1" (1/8" to 1-5/16")	0.06 CFM/FT.2 @ 6.24 PSF	15 PSF – Static 15 PSF – Dynamic	40 PSF – Design 60 PSF – Overload	0.38 - Aluminum PP 0.32 - Thermal PP	73 – Aluminum PP 80 – Thermal PP	32 STC 26 OITC

** U-Factor per NFRC 100. Refer to the U-Value table at: www.tubeliteinc.com/products/curtainwall/400t-thermal-curtainwall/

DISCLAIMER: Tubelite takes no responsibility for product selection or application, including, but not limited to, compliance with building codes, safety codes, laws, merchantability or fitness for a particular purpose; and further disclaims all liability for the use, in whole or in part, of this Technical Guide in preparation of project specifications and/or other documents. Technical Guides are subject to change at any time, without notice, and at Tubelite's sole discretion. ©2017 Tubelite Inc.

122722

TUBELITE®

DEPENDABLE

LEADERS IN ECO-EFFICIENT STOREFRONT,
CURTAINWALL AND ENTRANCE SYSTEMS

400T SERIES CURTAIN WALL

Tubelite reserves the right to change system configuration without prior notice when deemed necessary for product improvements.

Laws and building & safety codes governing the design and use of glazed entrance, window and curtain wall systems vary widely. Tubelite does not control the selection of product configurations, operating hardware or glazing materials, and assumes no responsibility thereof.

Standard Details 1/4 scale

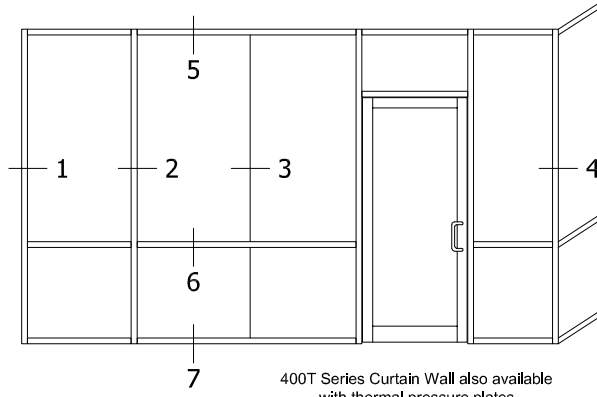

400T Series Curtain Wall also available with thermal pressure plates

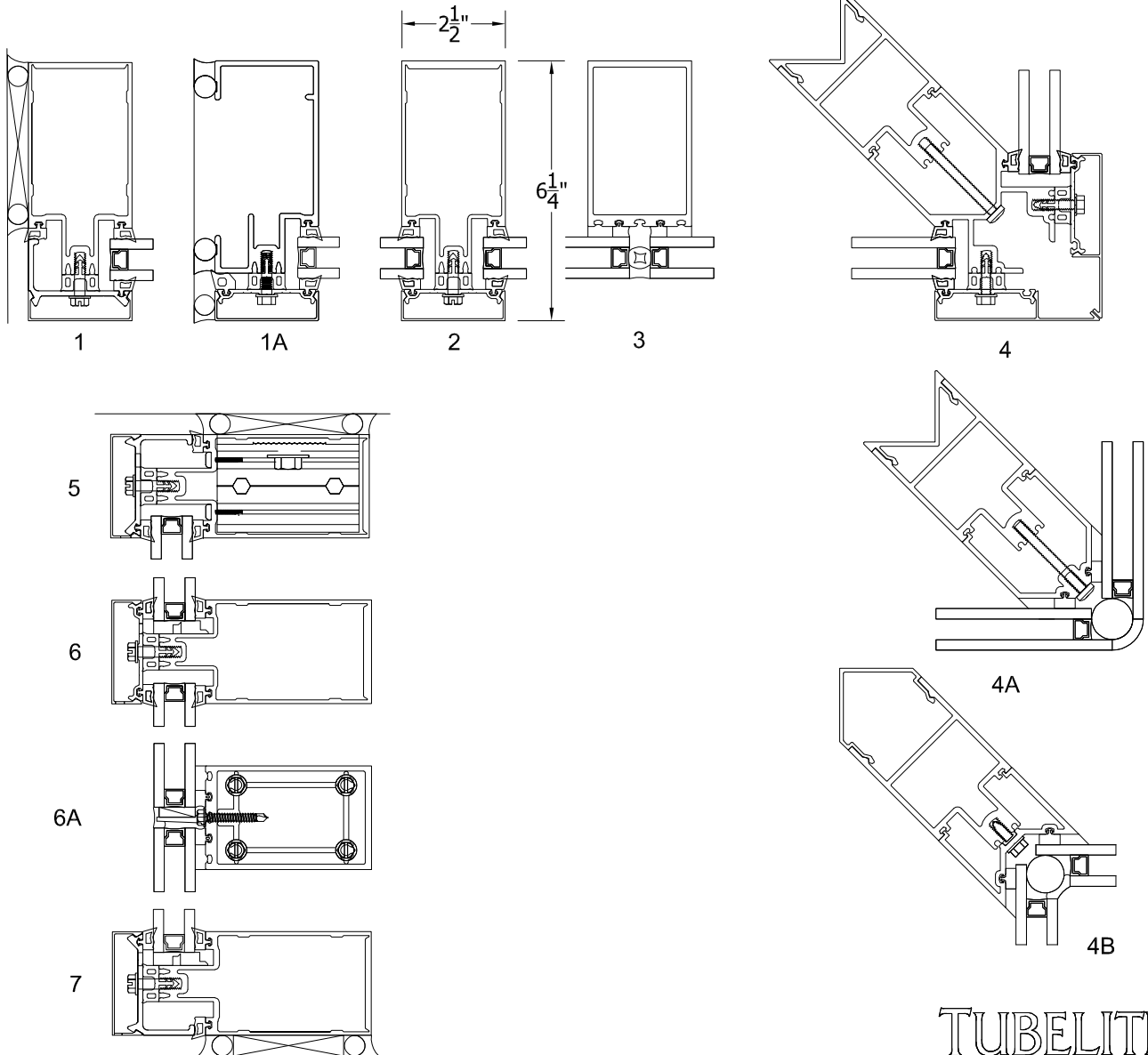

January 2020

TUBELITE®
DEPENDABLE
LEADERS IN ECO-EFFICIENT STOREFRONT,
CURTAINWALL AND ENTRANCE SYSTEMS

For specific product applications, contact your Tubelite representative.
Details on this page represent standard details found on our website.
For more options, visit our website at www.tubeliteinc.com/400t-thermal-curtain-wall/

400T SERIES CURTAIN WALL

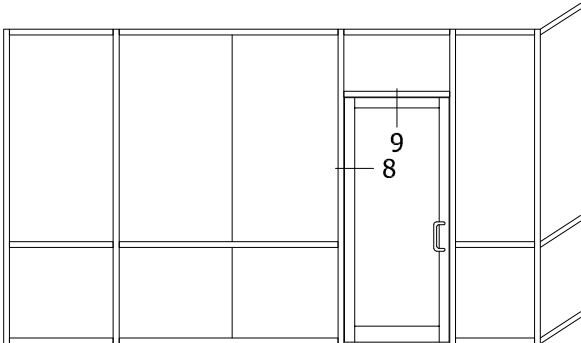

400T Series Curtain Wall also available with thermal pressure plates

Tubelite reserves the right to change system configuration without prior notice when deemed necessary for product improvements.

Laws and building & safety codes governing the design and use of glazed entrance, window and curtain wall systems vary widely. Tubelite does not control the selection of product configurations, operating hardware or glazing materials, and assumes no responsibility thereof.

Optional Details
1/4 scale

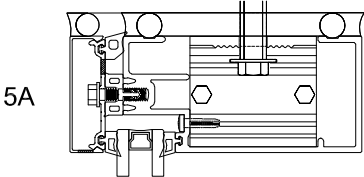

5A

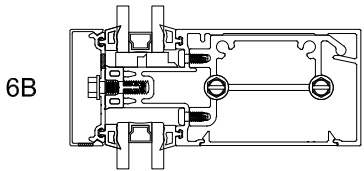

6B

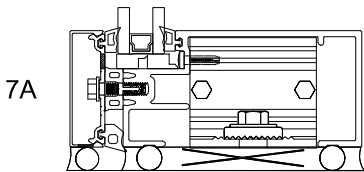

7A

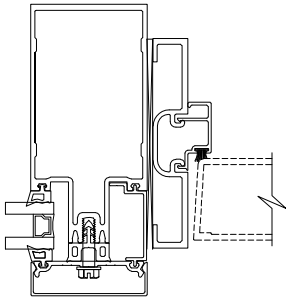

8

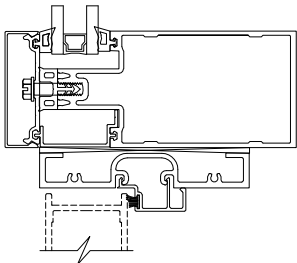

9

TUBELITE[®]
DEPENDABLE
LEADERS IN ECO-EFFICIENT STOREFRONT,
CURTAINWALL AND ENTRANCE SYSTEMS

January 2020

For specific product applications, contact your Tubelite representative.
Details on this page represent standard details found on our website.
For more options, visit our website at www.tubeliteinc.com/400t-thermal-curtain-wall/