

AIRFOIL		
PART NUMBER	"A" LENGTH	BLADE QNT'Y
P3901A	20 INCHES	3
P3901B	25 INCHES	4
P3901C	30 INCHES	5
P3901D	35 INCHES	6
P3901L/R	50 INCHES	CUT TO FIT

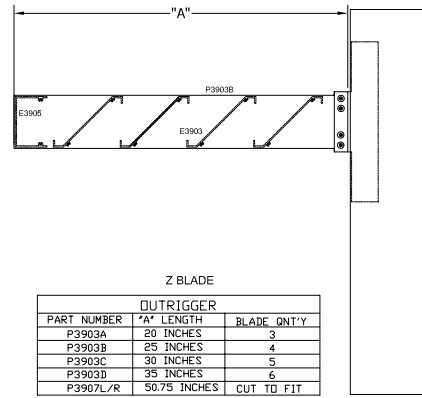

Z BLADE		
PART NUMBER	"A" LENGTH	BLADE QNT'Y
P3903A	20 INCHES	3
P3903B	25 INCHES	4
P3903C	30 INCHES	5
P3903D	35 INCHES	6
P3907L/R	50.75 INCHES	CUT TO FIT

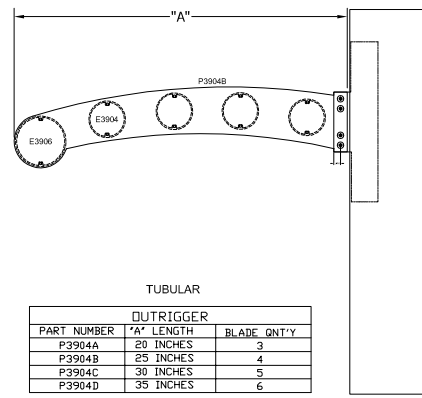

TUBULAR		
PART NUMBER	"A" LENGTH	BLADE QNT'Y
P3904A	20 INCHES	3
P3904B	25 INCHES	4
P3904C	30 INCHES	5
P3904D	35 INCHES	6

SINGLE BLADE

AIRFOIL		
PART NUMBER	"A" LENGTH	BLADE QNT'Y
E3940	6 INCHES	1
E3925	9 INCHES	1

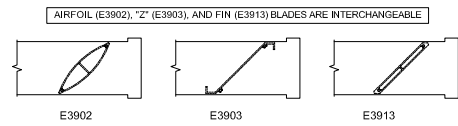

TYPICAL OUTRIGGER AND BLADE OPTIONS

MAXBLOCK SUNSHADES
MULTIPLE AND SINGLE BLADE SYSTEMS FOR CURTAIN WALL, WINDOW WALL & STOREFRONT APPLICATIONS

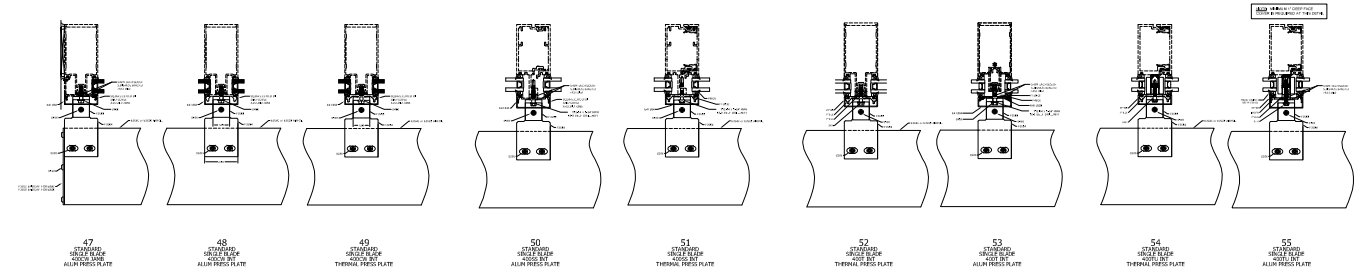

SINGLE BLADE CURTAINWALL

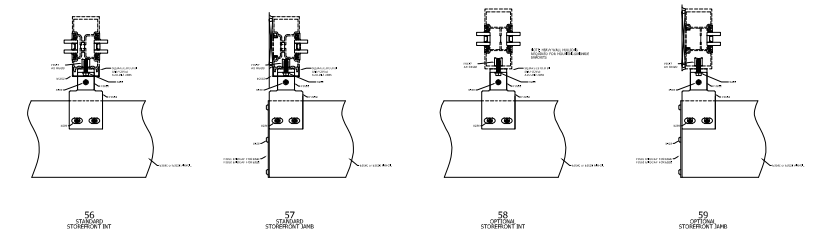

SINGLE BLADE STOREFRONT

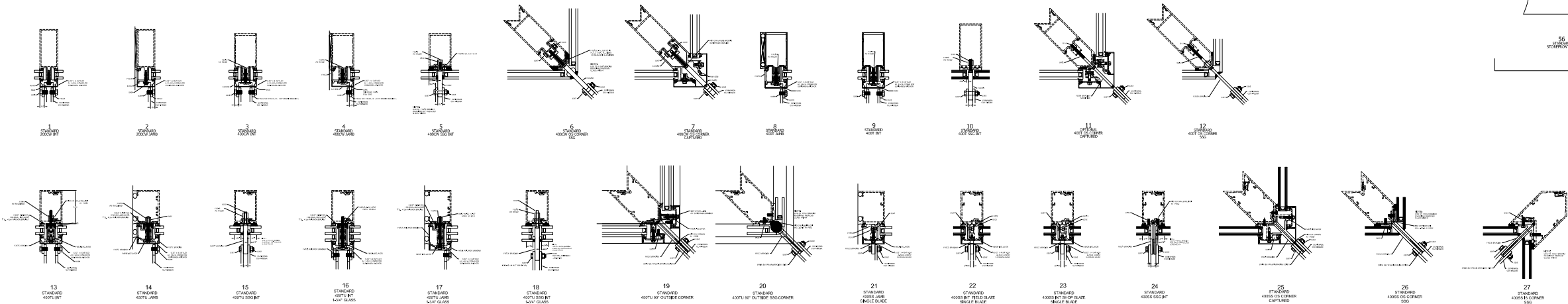

950SG WINDOW WALL

CURTAINWALL

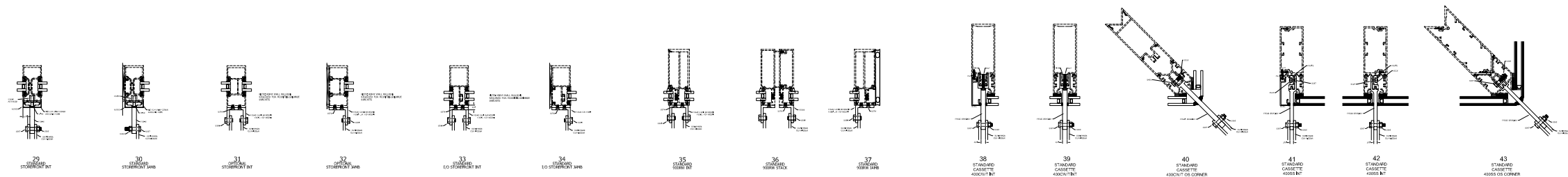

STOREFRONT

WINDOW WALL

CASSETTE

NOTE: SUNSHADE BRACKETS ARE NOT AVAILABLE FOR CURTAIN WALLS, CORNER CASSETTE APPLICATIONS, CORNELL TUBELITE ENGINEERING FOR ALTERNATE USAGE.

TUBELITE®
DEPENDABLE
LEADERS IN ECO-EFFICIENT STOREFRONT, CURTAINWALL AND ENTRANCE SYSTEMS