

TYPICAL ELEVATION
4-BAR / CAMS
WITH OPTIONAL SCREEN

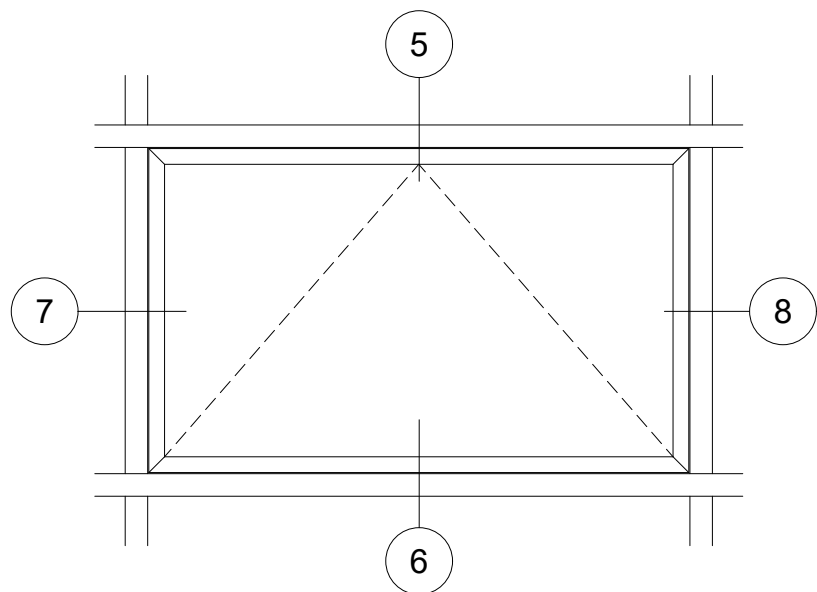

TYPICAL ELEVATION
4-BAR / ROTO-MPL
WITH OPTIONAL SCREEN

900RW INSTALLATION

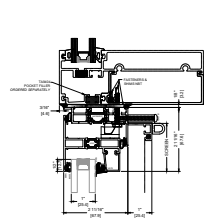

1
HEAD
FLATBACK INSTALLATION
STANDARD

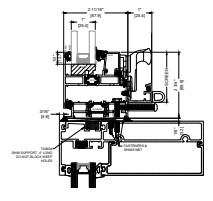

2
SILL
FLATBACK INSTALLATION
STANDARD

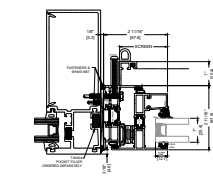

3
FLATBACK INSTALLATION
STANDARD

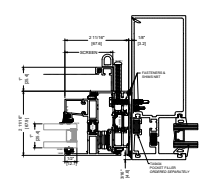

4
JAMB
FLATBACK INSTALLATION
STANDARD

CURTAIN WALL INSTALLATION

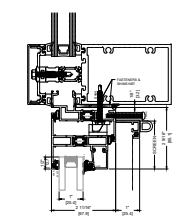

1A
HEAD
CURTAIN WALL INSTALLATION
STANDARD

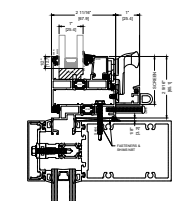

2A
SILL
CURTAIN WALL INSTALLATION
STANDARD

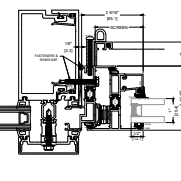

3A
FLATBACK CURTAIN WALL
INSTALLATION
STANDARD

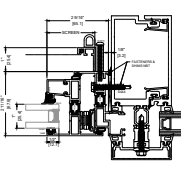

4A
JAMB
CURTAIN WALL INSTALLATION
STANDARD

STOREFRONT INSTALLATION

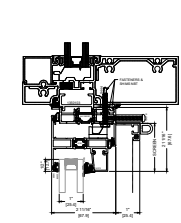

1B
HEAD
SF ADAPTOR
STANDARD

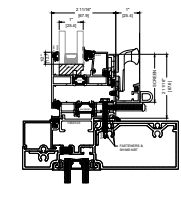

2B
SILL
SF ADAPTOR
STANDARD

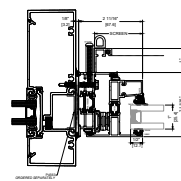

3B
FLATBACK SF
INSTALLATION
STANDARD

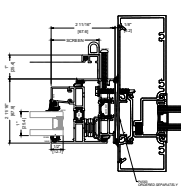

4B
JAMB
SF INSTALLATION
STANDARD

900RW INSTALLATION

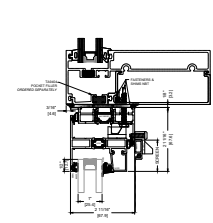

5
HEAD
FLATBACK INSTALLATION
STANDARD

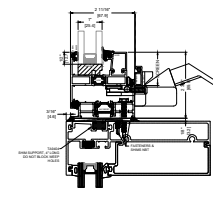

6
SILL
FLATBACK INSTALLATION
STANDARD

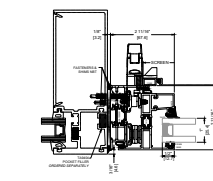

7
FLATBACK INSTALLATION
STANDARD

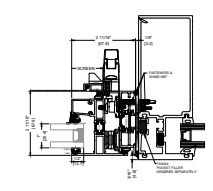

8
JAMB
FLATBACK INSTALLATION
STANDARD

CURTAIN WALL INSTALLATION

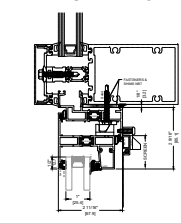

5A
HEAD
CURTAIN WALL INSTALLATION
STANDARD

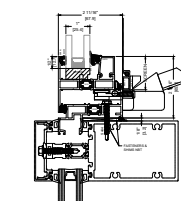

6A
SILL
CURTAIN WALL INSTALLATION
STANDARD

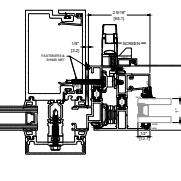

7A
FLATBACK CURTAIN WALL
INSTALLATION
STANDARD

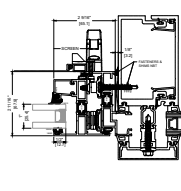

8A
JAMB
CURTAIN WALL INSTALLATION
STANDARD

STOREFRONT INSTALLATION

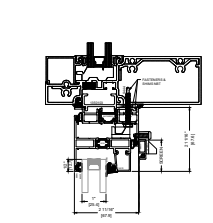

5B
HEAD
SF ADAPTOR
STANDARD

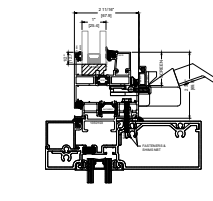

6B
SILL
SF ADAPTOR
STANDARD

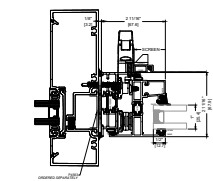

7B
FLATBACK SF
INSTALLATION
STANDARD

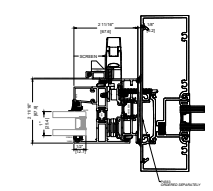

8B
JAMB
SF INSTALLATION
STANDARD

4-BAR / CAMS

4-BAR / ROTO with MPL

1350 SERIES INSERT VENT
DUAL GLAZED
AWNING

OPTIONAL GLAZING
GLASS SHOWN DOES NOT NECESSARILY REPRESENT FINAL CONFIGURATION.
CONSULT GLASS MANUFACTURER FOR SPECIFIC GLASS MAKE UP.



TUBELITE®
DEPENDABLE

LAST REVISED: 9/27/2023