

TYPICAL ELEVATION

400T SERIES

400T SERIES CURTAIN WALL PERIMETER SHEET

7.75" SYSTEM DEPTH, 5.5" BACK MEMBER

INTERSTORY HORIZONTAL EXPANSION, ALUMINUM PRESSURE PLATE

1 STANDARD HEAD

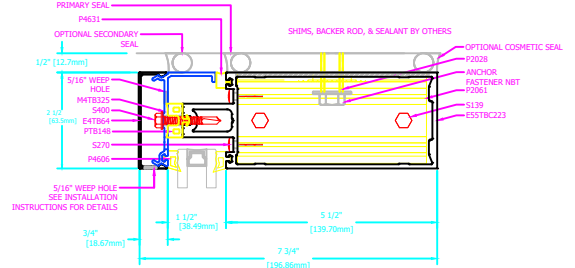

2 STANDARD TUBULAR INTERMEDIATE HORIZONTAL

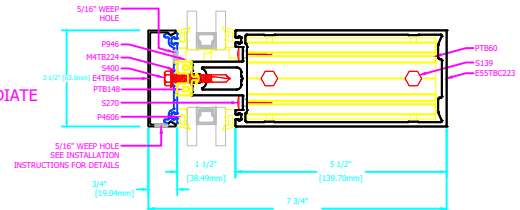

3 STANDARD TUBULAR SILL

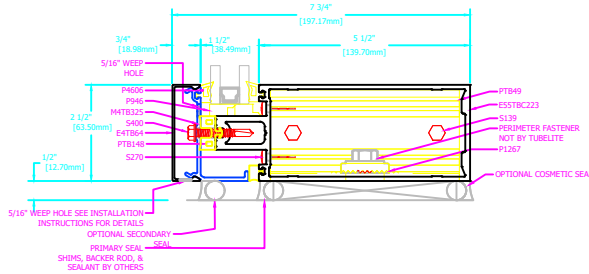

4 STANDARD TRANSOM WITH SUB-FRAME AND GLAZING POCKET FILLER

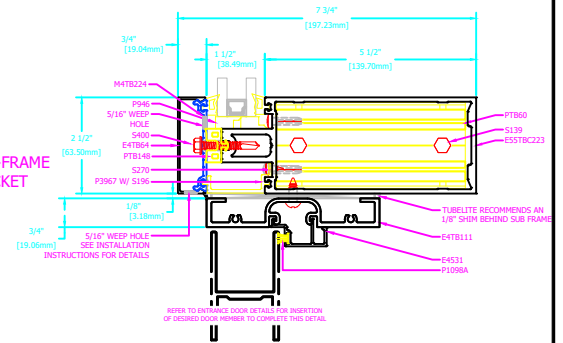

HORIZONTAL DETAILS

Standard Details
1/5 scale

September 2022

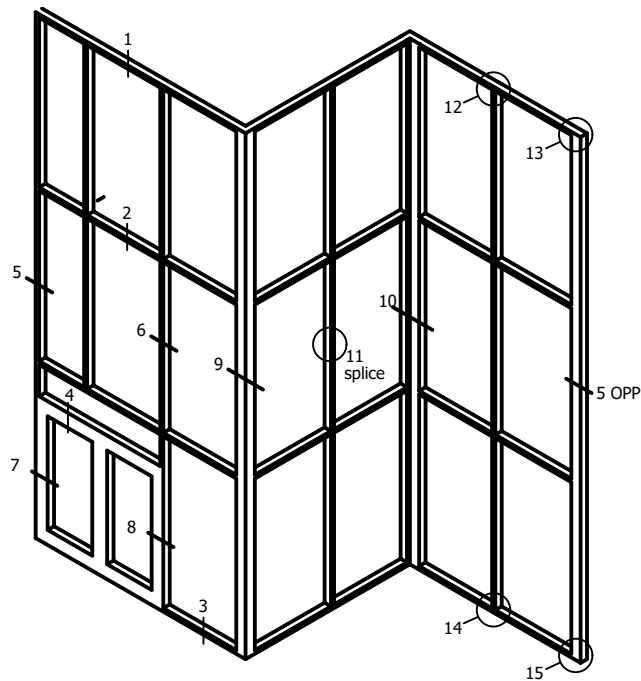

TYPICAL ELEVATION

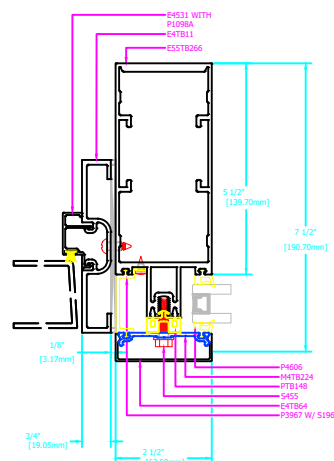

8
STANDARD
DOOR JAMB AT SIDELITE W/
VINYL POCKET CLOSER

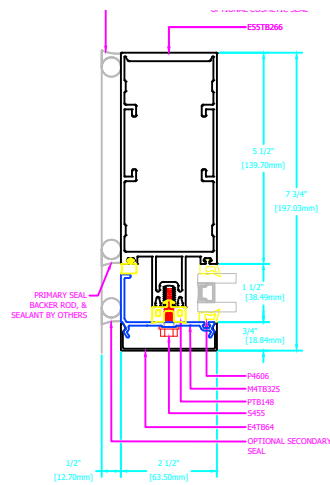

5
STANDARD
TUBULAR JAMB

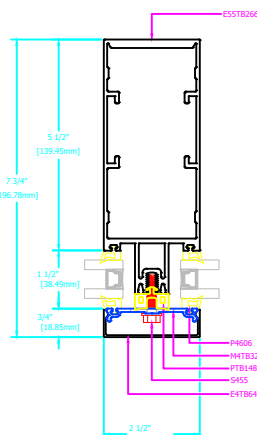

6
STANDARD
TUBULAR MULLION

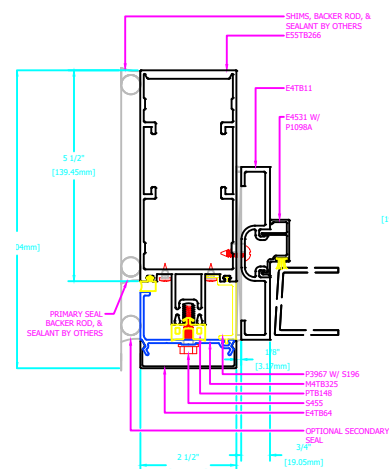

7
STANDARD
DOOR JAMB AT PERIMETER PRESSURE
PLATE W/ ALUMINUM POCKET CLOSER

VERTICAL DETAILS

Standard Details
1/5 scale

September 2022

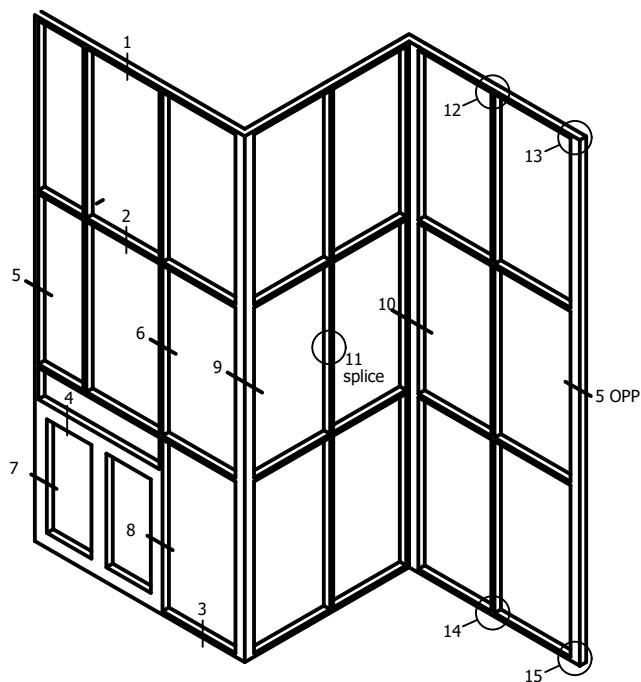

TYPICAL ELEVATION

FACE COVER
PINNING

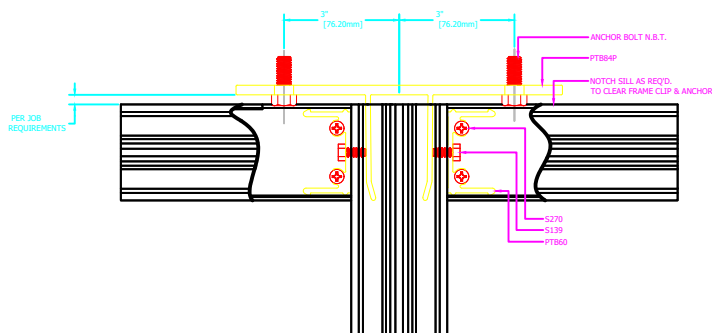

12
STANDARD
"T" ANCHOR AT HEAD

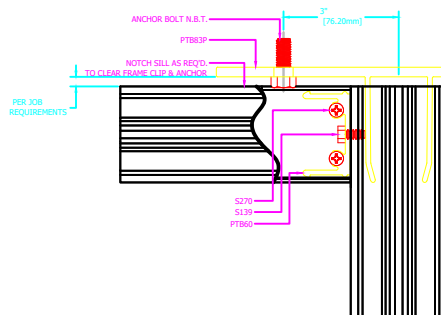

13
STANDARD
"F" ANCHOR AT HEAD

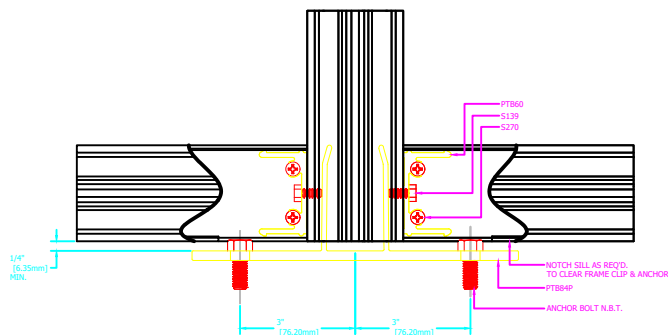

14
STANDARD
"T" ANCHOR AT SILL

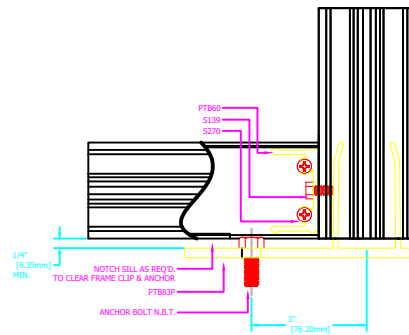

15
STANDARD
"F" ANCHOR AT SILL

ANCHOR DETAILS

Standard Details
1/5 scale

September 2022