

Door Hardware & Accessories

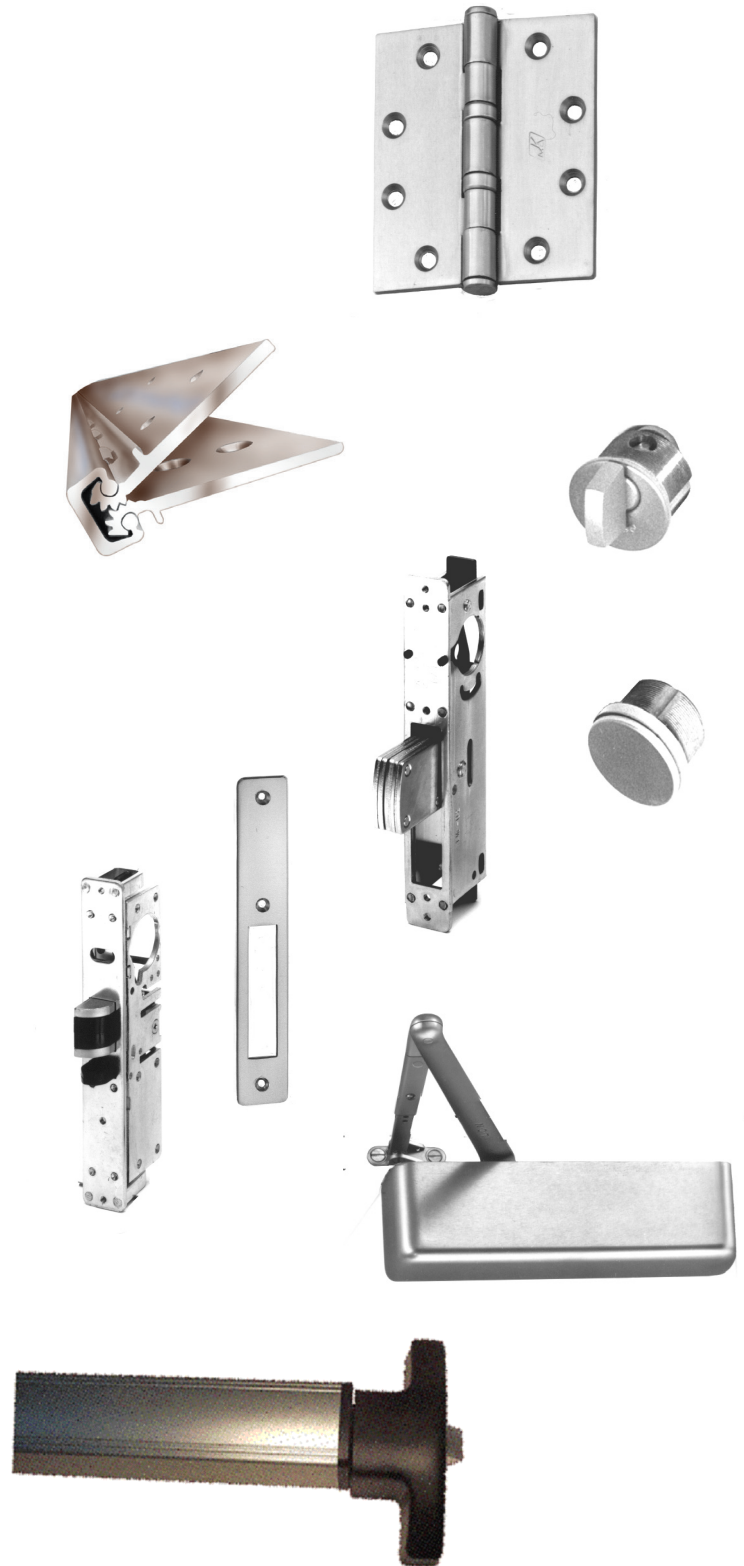

TUBELITE®
DEPENDABLE

7.02 Hardware & Accessories Mid-Panel Concealed Vertical Rod Panic First Choice 3100 Series Exit Device

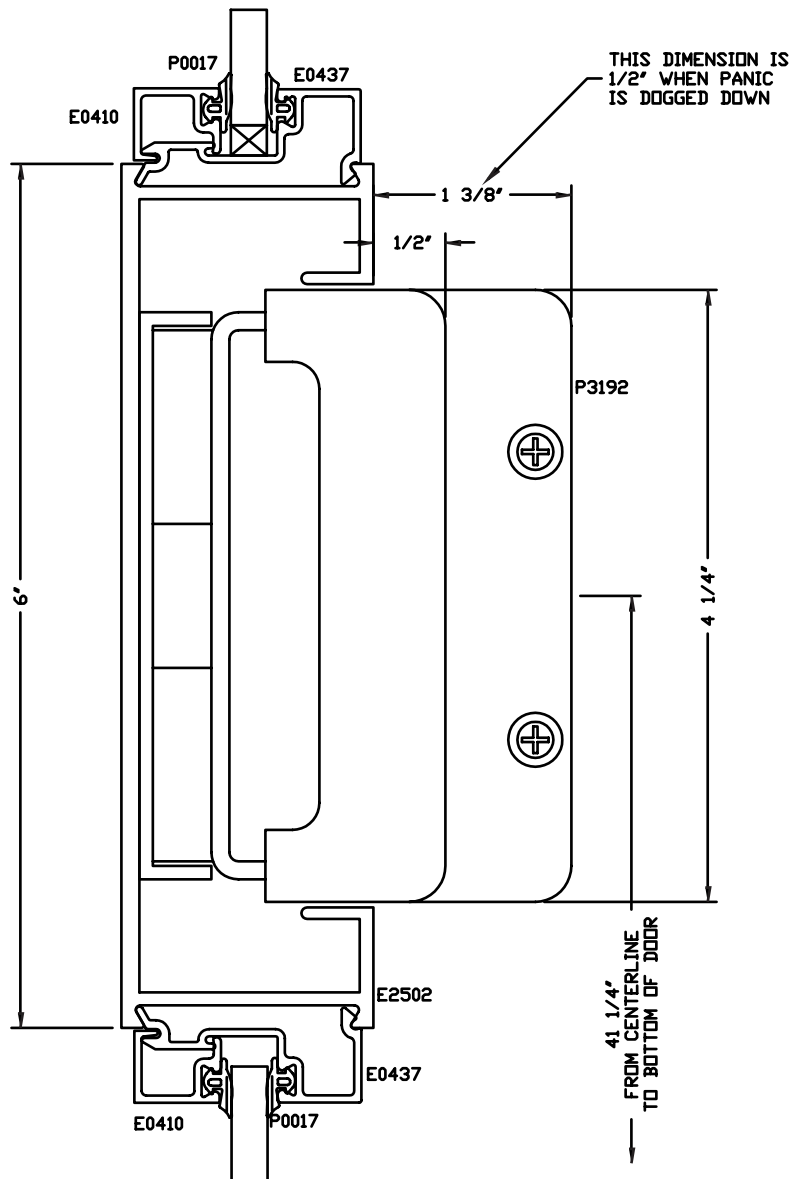
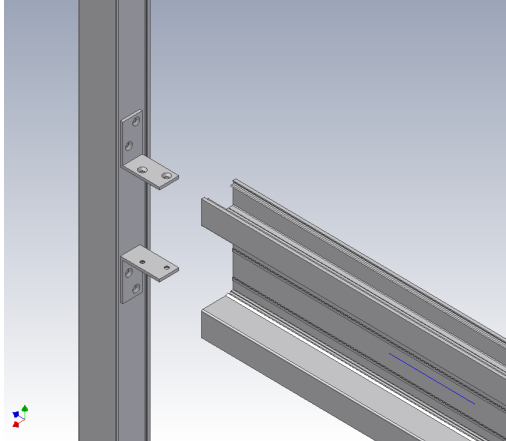

7.03 Hardware & Accessories Hinges & Pivots

P092 Mortised Butt Hinge

Both leaves of this hinge are punched and countersunk so they can be mortised into the door stile and frame. They are specially swaged to provide 1/16" clearance between leaves when parallel. Overall dimension is 4" x 4 1/2" when open. Button tips and plugs are standard. Five knuckle ball bearings are packed with grease to assure a quiet long life hinge.

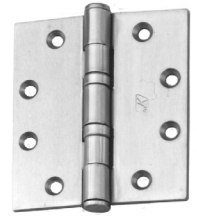

Offset Pivots

P795H - Top Frame Pivot for 3/16" backset doors

Cast aluminum body has oilite bronze bushing and is mortised into the door header and fastened with 3 countersunk screws



P795DT - Top Door Pivot for 3/16" backset doors

Cast aluminum body is securely attached to the door with 2 hex head bolts. A spring loaded hardened-steel pin permits easy installation of the door.



P795DB - Bottom Door Pivot for 3/16" backset doors

Cast aluminum body is securely fastened to the door with 2 hex head bolts. A full race bearing accepts the pivot pin on the floor portion.



P795 L/R - Floor Pivot for 3/16" backset doors

Cast aluminum body has a hardened steel pivot pin and is screw attached to the floor and door frame for complete rigidity. A vertical adjustment of 1/8" is possible without removing the door.



P795I L/R Intermediate Pivot

Use of intermediate pivots is recommended for offset hung doors over 3'-0" in width or over 7'-0" in height with 1/4" glass, and on all doors with glazing over 1/4" in thickness.

The P 751 is also used in heavy traffic areas or as a substitute for top pivot in concealed closer applications. Cast aluminum leaves are fully mortised into frame and door stile (requires reinforcing).



P1584 Continuous Hinges

Heavy Duty 83" [P1585 - 95", P1586 - 120"]

Continuous gear hinges made from aluminum. Concealed fasteners, no mortising of doors or frames required. These hinges are heavy duty for doors up to 450 lbs. and are flush mounted, no inset.

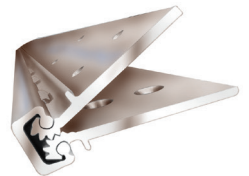

P971 Center Pivot - Floor Portion

For use at the floor on center pivot doors with or without a threshold. Bottom arm door portion is cast aluminum and sits on the pivot bearing mounted to the floor or threshold with a plated steel bracket and countersunk screws. Vertical adjustment of 1/4" is possible without removing door. Mill finish only.



7.04 Hardware & Accessories Door Closers



P 1783 **Overhead Surface Closer**

P1783 door closers are furnished standard with regular, parallel and top arms, with mounting screws in finishes to match doors. All closers feature field adjustable back-checks and individual closing and latching speed adjustments. P 1783 closers are heavy duty Grade 1, and are non-handed and have adjustable spring power to meet average entrance conditions.



P2200 **Overhead Surface Closer**

Tubelite/DORMA door closers are non-handed and furnished standard for regular, top jamb or parallel arm applications. Slim plastic covers, adjustable backcheck, self tapping fasteners and individual valves to adjust sweep and latch speed are standard features. Finishes available are Clear aluminum (689) and Bronze (695) Hold open versions are available on request.

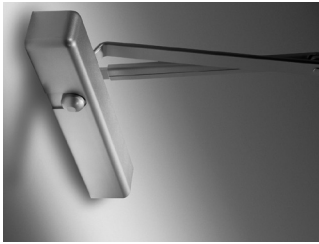

P2201 **Overhead Surface Closer**

Tubelite/DORMA door closers are non-handed and furnished standard for regular, top jamb or parallel arm applications. Slim plastic covers, adjustable backcheck, self tapping fasteners and individual valves to adjust sweep and latch speed are standard features. Finishes available are Clear aluminum (689) and Bronze (695) Hold open versions are available on request.

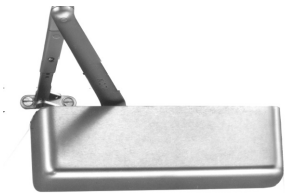

P4040 **Surface Overhead Closer**

This heavy duty non-handed closer package includes Parallel arm shoe #4040 62PA. Adapter plate for mounting must be specified.

P 4040 closers feature field adjustable spring power from size 2 through size 6 for exterior handicap doors with opening widths between 36" and 48". P 4041 closers have field adjustable spring power from size 1 through size 4 to provide the right amount of control for interior handicap doors with opening widths between 36" and 48".

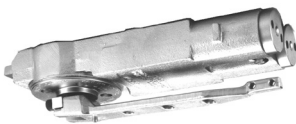

P2120 **Concealed Overhead Closer**

P2120 closers are non-handed and are furnished standard with clips and mounting screws for single or double acting Center Pivoted, Offset Pivoted and Butt Hinge applications. They have adjustable spring tensions to medium, with 90° or 105° swing, and hold-open or non hold-open models to meet various requirements. The hold open range varies between 85-90 degrees from the closed position

P1420
Maximum Security Deadlock

Standard long throw bolt of 5-ply laminated steel resists all types of saws. P 1420 accepts any 1 5/32" cylinder or thumbturn and has 1 1/8" backset on all stile widths. Lock mounts on back web of door stile and is spring loaded for easy adjustment. One 360° turn of the key retracts the counterbalanced bolt. Faceplate and cylinder are separate. May be used with Narrow, Medium and Wide Stile doors, and with conversion kits for 2 point (P 1010) and 3 point (P 1750) locking bolts.



P1422
Maximum Security Deadlock - Short Throw Bolt

15/16" bolt for special conditions, offers the same features and options as P 1420 long throw maximum security deadlock.

P1421
Deadlatch Lock

P 1421 locks offer the flexibility of traffic control during or after business hours for free entry or exit only at desired times. These locks are interchangeable with any MS 1850 deadlock of equal backset and faceplate shape. Latchlock bolt has 1/2" throw and is constructed of zinc alloy with hardened steel pins embedded in Delrin® plastic insert. An auxiliary bolt of the same material defeats use of a knife blade to gain entry. Backset is 1 1/8", and any standard 1 5/32" cylinder with MS cam may be used. A reverse turn of the key while the bolt is held retracted retains the bolt in that position. Faceplate, cylinder, optional lever handle and strike are separate. Lock mounts on back web of door stile and is spring loaded for easy adjustment.



P1424
Hookbolt Lock

Hook bolt locks may be used with Narrow, Medium & Wide Stile doors. They are ideal for use with sliding doors, and for extra security on pairs of doors, as they provide additional resistance to attempted prying. Materials and components are the same as the P 1420 deadlock with the exception of the hook shape bolt.



Lock Faceplates

Faceplates

P1408 - Radiused

Radiused faceplate for center pivoted doors and meeting stile for pairs of doors, has a durable double stitched pile weathersweep that extends the full length of the lock.

P1409 L/R - Beveled

Beveled faceplates are used on standard hinged or offset pivoted single doors with P 1420 MS deadlocks. Extruded aluminum face for lock is handed for swing of door, and lays flush with door stile when lock is properly adjusted.



7.06 Hardware & Accessories Lock Faceplates



Faceplates

P1410 - Radiused

Radiused faceplate for center pivoted doors, and meeting stile on pairs of doors with P 1421 latch lock. A double stitched pile weathersweep extends the full length of the lock.

P1411 L/R - Beveled

Beveled faceplates are used on standard hinged or offset pivoted doors with P 1421 latch locks. Extruded aluminum face for lock is handed for swing of door, and lays flush with door stile when lock is properly adjusted.

Face Strike



P1171 - Flat

Flat face strike is used with P 1421 latch lock on frame jamb for beveled door stiles. Strike is made of buffed stainless steel and includes steel mounting plate, molded black plastic dust box and screws.

P1172 - Radiused

Radiused face strike is used with P 1421 latch lock on inactive leaf for pairs of doors. Materials and parts are similar to the flat face strike.



P059

Flush Bolt

Use one each P 059 flush bolt for locking pairs of doors at the top and bottom of the inactive leaf. Zinc die cast housing is 4 1/4" long x 15/16" wide and screw applied through door stile radiused face. Bolt has adjustable throw on 12" threaded rod and includes nylon guide.



P1010

Threshold Bolt

Two point lock conversion kit for any MS P 1420 deadlock on single doors or pairs of doors. A 360° turn of key or thumb turn simultaneously throws the deadlock bolt into the opposite door leaf or frame and drop-bolt into the threshold. Threshold bolts are constructed of 3/8" hardened steel, plated for corrosion resistance, and mounted on a threaded rod for exact adjustment to cylinder height. P 1010 may be used in conjunction with P 1750 header bolt for three point locks.



P1750

Header Bolt

Three point lock conversion kit for any MS P 1420 deadlock and P 1010 threshold bolt on single doors or pairs of doors. A 360° turn of key or thumb turn simultaneously throws the deadlock bolt into the opposite door leaf or frame, kicking positioner bolt into the door header and drop-bolt into the threshold. Header bolts are 1/2" x 1 1/2" with 5/8" throw, and expands in a scissors action to center itself in its strike as it rises with the upward action of the deadbolt. Minor adjustment of the rod length is made by turning the nylon end of a threaded rod. P 1010 threshold bolt and P 1420 deadlock are described above.

Hardware & Accessories

P572

Standard Mortised Cylinder

For use on all of our doors without panic exit devices. 1 5/32" diameter cylinder, plug and five-pin tumblers are made of brass. Face of lock cylinder is made of anodized aluminum to match door. Use 1 per door with P 023 thumb turn for finger operation from the interior side of the door.



P009

Dummy Mortised Cylinder

Use on doors in lieu of P 572 or P 023 where restricted access to lock is desired. 1 5/32" diameter cylinder, and plug are made of zinc. Face of dummy cylinder is made of anodized aluminum to match door. Specify interior or exterior location.



P573

Standard Rim Cylinder

Use on all panic exit device doors.



P023

Thumb Turn

Use on interior lock stile of all doors without a panic exit device. The thumb turn allows operation of the door lock without using a key.



P716

Cylinder Guard

Protects lock cylinder from removal by wrenches, prying or sawing to gain unauthorized entry. Security ring on exterior of door is made of hardened steel and turns freely when properly snap-fit with retainer plate on interior of stile wall. Painted finish to match door. Order cylinder separately.



Exit Devices

P1008

Latch Paddle Exit Device

Alternate deadlatch operator for P 1421 lock may be used in lieu of lever handle or knob, and may be ordered for push or pull applications. Zinc alloy housing with black finish houses the operating mechanism and is secured to the door stile to resist pressure from any direction. Extruded 5 3/8" x 3" aluminum paddle in clear anodized finish extends 2 15/16" from face of door stile.

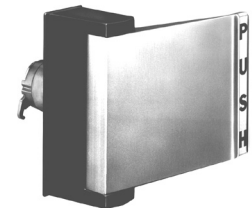

P348a

Lever Handle

Operator handle for P 1421 deadlatch is 3 1/2" long and shaped for easy grip while keeping thumb and knuckles safely away from door and jamb. Handles are available in satin chrome plated zinc alloy or black Delrin® nylon. Cam plug is secure in latch body by cylinder set screw and rigidly tied to the handle escutcheon by hardened steel pins.

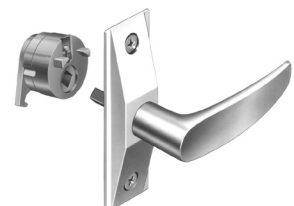

7.08 Hardware & Accessories Panic Exit Devices



P3692 Concealed Rod Panic

Concealed vertical rod type panic exit device provides two latching points, one each at the top and bottom of the door, except when the crash bar is activated or when "dogged" open by the lock cylinder or by concealed retracting screws. Passage of large objects through pairs of doors is not obstructed by a vertical mullion between the doors. Touch bar projects 1 1/2" from face of door and has heavy duty springs with nylon button type silencers for durable, quiet operation. Anodized high performance finish to match doors. Order cylinders separately.

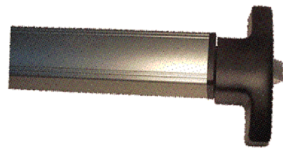

P3792 Rim Mounted Panic

Rim type panic devices provide one latch point at the lock stile of a door, except when the crash bar is activated, or when "dogged" open by the lock cylinder or by concealed retracting screws. A vertical mullion is required between pairs of doors. Touch bar projects 1 1/2" from face of door and has heavy duty springs with nylon button type silencers for durable, quiet operation. Anodized high performance finish to match doors. Order cylinders separately.

Push Bars



P1565 Standard Push Bar

1" diameter aluminum push bar has 2 1/4" projection from the face of the lock stile, which tapers to fasten flush to the face of the hinge stile. It is designed to match Tubelite's P 1564 standard pull handle. P 1565 is available in sizes for 36", 42" and 48" doors and can be cut down for custom sizes. Anodized, Stainless Steel and Brass finishes are available. Can be used on center pivoted doors, as well as butt hinges and offset pivots.

Pull Handles

P1564

Standard Pull Handle

1" diameter offset aluminum pull handle features "Barrier Free Design" with 3 1/2" projection from face of door. P 1564 measures 8" from center-to-center of thru-bolt mounting. Use with our P 1565 standard push bar.



P1567

Wire Pull Handle

1" diameter offset aluminum pull handle features "Barrier Free Design" with 3 1/2" projection from face of door. P 1567 measures 8" from center-to-center of stud mounting, for surface application.



P1568

Wire Pull (P-005 Replacement)

1" diameter offset aluminum pull handle features "Barrier Free Design" with 3 1/2" projection from face of door. P 1568 measures 7" from center-to-center of stud mounting to allow replacement of obsolete P-005 pull handle.



7.10 Hardware & Accessories Thresholds

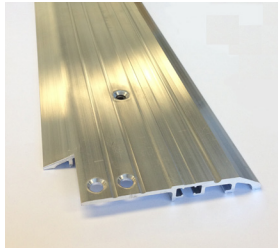

X36 thru 72 0PW & AW Standard Door Thresholds

Extruded aluminum thresholds are machined to fit the type of door, size and type of hinge or pivot. They are furnished standard with the door unless specified otherwise. Standard thresholds are 1/2" in height and are beveled to the floor on both sides to provide easy access for wheelchairs and strollers.

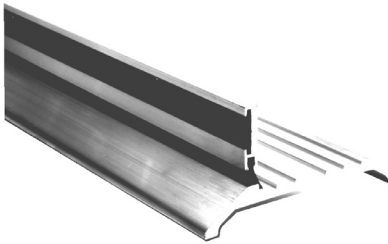

P1275, 1276, & 1277 Weathersweep

Vinyl weathersweep is screw applied to the bottom of the door with concealed fasteners on the mounting strip. Cut to fit doors up to 4'-0" in width. Finish to match door.

Miscellaneous



P1580 Electric Strike











Provides remote electrical control for doors equipped with P 1421 latchlocks, and lever or knob-set operators. Electrical actuation unlocks the strike jaw, releasing the latchbolt, and allowing the door to be opened without operating the latch.

Requires 24 volt AC current. Transformer and related wiring are not included. See our P1421 latchlock and accessories.

P2454 Electric Strike

Provides remote electrical control for Rim Panic doors. Semi-mortised for 1/2" Pullman type latch bolts (no auxilliary bolt) fail safe/fail secure, 12/16/24 volt AC/DC intermittent.

7.11 Hardware & Accessories

Door Gasket				
Illustration	Part Number	Description	Unit	Rolls Per Box
	P0017	Glazing Gasket – .072 Face Clearance Standard Doors - 1" & 1/4" Infill	500 foot rolls	3
	P912	Glazing Gasket– .219 Face Clearance Standard Doors – 3/4" Infill	250 foot rolls	
	P1477	Glazing Gasket– .040 Face Clearance Standard Doors – 5/16" Infill	500 foot rolls	
	P1112	Glazing Gasket– 3/16" Face Clearance	500 foot rolls	
	P013A	Door Pile Weathering	500 foot rolls	4
	P013D	Door Stile Pile Weathering: E0057, 0088, 0131, 1049 & 0418 Standard Doors	500 foot rolls	4
	P1098A	Weatherseal Pile Weathering (Standard door stop pile with vinyl seal)	625 foot rolls	4
	P6296	Weatherseal Bulb Weathering (Standard Door Stop)	500 foot rolls	2
	P938	Wool Pile for Adjustable Astragal	1,500 foot rolls	1
	P830	Wiper Blade for P1275, P1276, P1277 Weathersweep	500 foot rolls	1

7.12 Standard Entrances Panic Exit Device Locations

CAD DETAIL FILE NO.
090PANICELEV

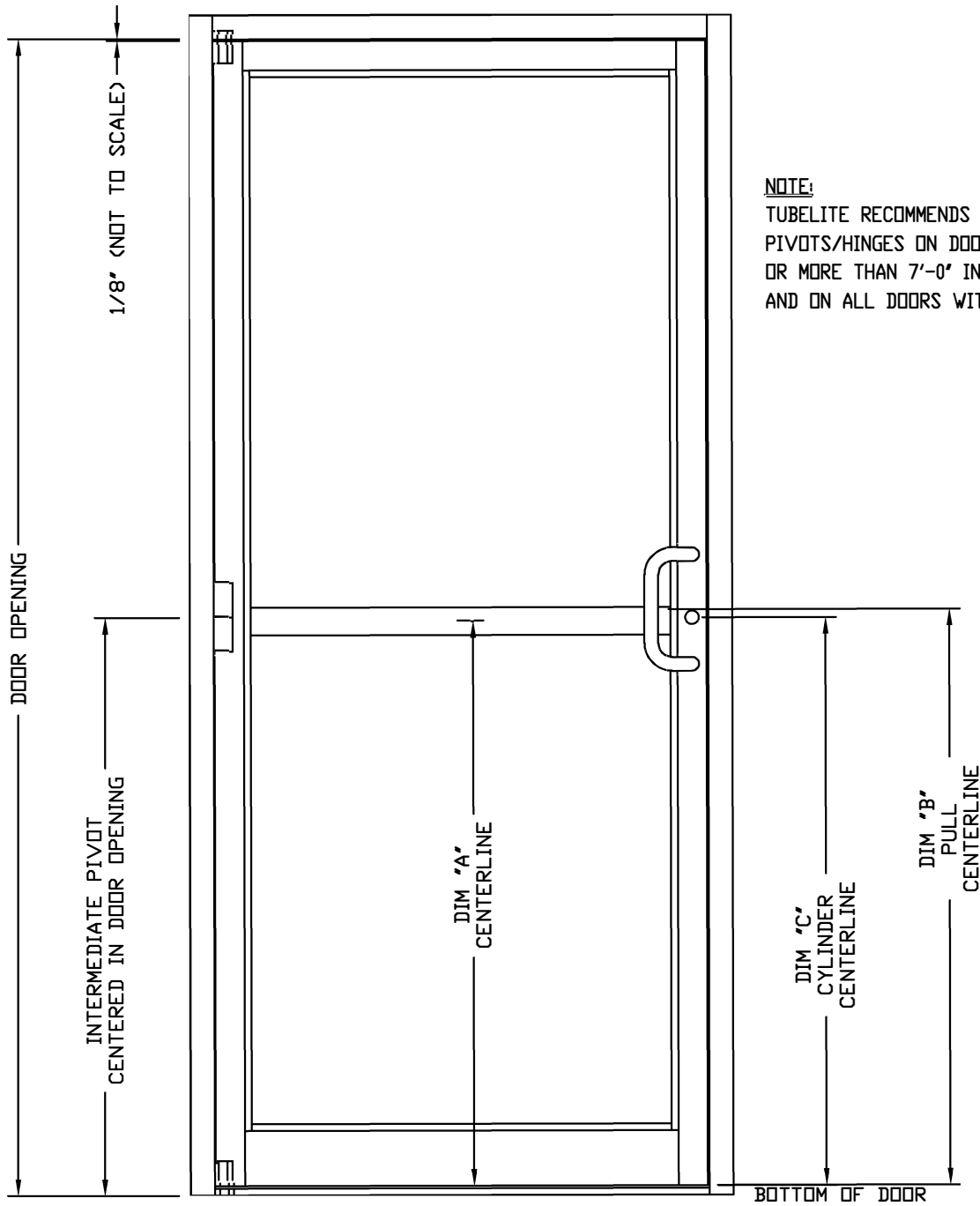

PANIC	DIM 'A'	DIM 'B'	DIM 'C'
P3692	40 5/8"	41 5/8"	41 9/16"
P3792	40 5/8"	41 5/8"	40 7/8"
P3192	41 3/32"	41 3/32"	41 1/16"

7.13 Standard Entrances Hardware Locations

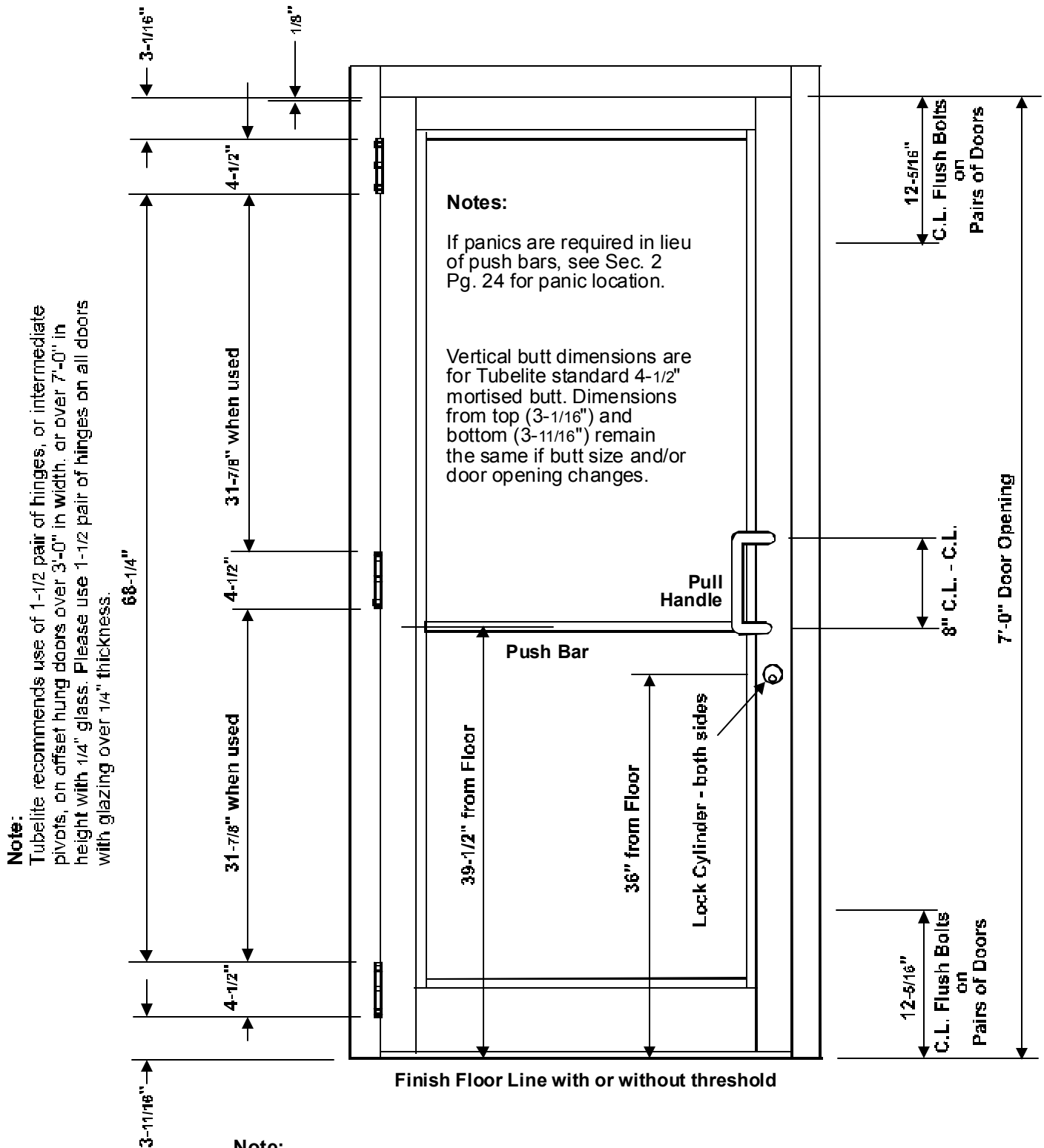

Note:
On custom door opening heights, the bottom dimensions of 3-11/16" and top dimensions of 3-1/16" are constant. Intermediate dimensions of 68-1/4" and 31-7/8" will vary accordingly. Dimensions of 39-1/2" and 36" are constant.



TUBELITE[®]

DEPENDABLE

LEADERS IN ECO-EFFICIENT STOREFRONT,
CURTAINWALL AND ENTRANCE SYSTEMS

www.tubeliteinc.com
800.866.2227